



Brought to you by



Association of Illinois
Electric Cooperatives

Your Touchstone Energy® Partner 



Lower your cost of living

We never seem to forget that the cost of owning a car includes the cost of gasoline. But for some reason many of us forget that the cost of owning a home includes more than a mortgage, insurance and taxes – it also includes the energy bills. You might ask what local or state tax credits and incentive programs are available for home energy efficiency. Talk to your lender about the advantages of energy efficient mortgages. Your local electric co-op’s energy experts and this manual can help you build a home that gets more “miles-to-the-gallon.”



If you don't remember anything else... remember this

- Though some of the items presented in this booklet seem insignificant, it is the use of the total concept that provides for large energy savings.
- Corner and partition construction should minimize air pockets and allow for full insulation.
- It is recommended that cellulose or foam insulation be used in ceilings and walls. We DO NOT recommend using fiberglass insulation
- When insulating the basement or crawl space, do not forget to insulate the box sill. We recommend foam insulation in the box sill. Never use fiberglass here.
- Caulking and sealing of the exterior wall and its components is a vital part of the overall efficiency of a home.
- The attic area should be insulated to a minimum R-49. We highly recommend using blown cellulose in attics.
- Basements have more heat loss than most people realize.
- Geothermal heat pumps are the most efficient heating/cooling systems available today. They move heat energy rather than create it and are three to four times more efficient than a gas furnace.
- Because windows and glass doors are major areas of heat loss and gain, they should be sized so they are no more than 10 percent of the floor area.
- Heating and cooling ductwork should be within the conditioned space of the home, but when this isn't practical or possible, ducts should be air-sealed and insulated to IECC specifications.



Illinois Touchstone Energy Home

Building the home of your dreams

Making an energy efficiency investment in your new home today will mean you'll have a comfortable, quiet and economical home for life. This Illinois Touchstone Energy Home manual can help you achieve these goals.

Table of Contents

Introduction	4
Controlling Comfort	5
Moisture Control	5-6
Recommended Construction, Air Sealing & Insulating Standards	
Caulking and Sealing	6
Walls	7-8
Basement Walls	8
Structural Insulated Panels	8
Insulated Concrete Forms	9
Steel Framing	9
Roof/Ceiling Construction and Ventilated Attics	10-11
Floors	12
Floors over Crawl Space	12
Concrete Slab Floors	12
Windows and Doors	13-14
Heating, Ventilation and Air-Conditioning Systems (HVAC)	15-16
Domestic Hot Water (DHW)	17
Lighting	17
Energy Certificate	18
Conclusion	18
Summary of Recommended Construction Standards	19
Insulation Values	Back Cover

Published by the Association of Illinois Electric Cooperatives

NOTE: This manual is provided for informational purposes only. The Association of Illinois Electric Cooperatives has no control over the conditions under which this information may be used; therefore, the electric cooperatives make no warranty, expressed or implied, with respect to the accuracy, completeness, or usefulness of the information, nor assumes any liabilities with respect to the use of any information, apparatus, product or process disclosed in this manual.

Introduction

The Illinois Electric Cooperatives are pleased to provide the Illinois Touchstone Energy Home guide to Building the Home of your Dreams. This booklet provides lots of great ideas on how to build an energy efficient home that will provide you and your family with a comfortable, affordable and efficient home for many years.

This is the third version of “Building the Home of your Dreams.” The cooperatives produced two earlier versions, under the Certified Comfort Home label, before updating the current booklet. This new booklet meets the requirements of the 2012 International Energy Efficiency Code, which has been adopted in the State of Illinois. The electric cooperatives recommend that any new home meet the 2012 IEEC, which is Illinois law.

A committee of Illinois electric cooperative energy experts, is responsible for this latest effort. Also helping out was Darren Meyers of Build RIGHT Illinois. As an expert on energy efficiency and the 2012 code, the cooperatives called upon Darren to ensure that the recommendations in this new publication met the code requirements.

Many thanks to the committee and Darren for their work.

If you are planning to build a new house in the future, we advise building to the standards in this booklet. In addition, the concepts and ideas referenced in this booklet generally apply to renovation and remodeling projects as well.

If in doubt about anything in this booklet, or have questions involving new home construction, please remember to ALWAYS contact the energy efficiency professionals at your electric cooperative. We'll be glad to help you successfully build the ENERGY EFFICIENT “Home of your Dreams.”



Conventional Construction Methods

 Energy Dollar



60¢

Heating & Cooling



15¢

Water Heating



25¢

Other

=

0¢
Savings

Illinois Touchstone Energy Home Construction Standards

 Energy Dollar



25¢

Heating & Cooling



10¢

Water Heating



25¢

Other

=

40¢
Savings

Controlling Comfort



Radiation



Conduction



Convection



A home loses heat in three ways, as shown in figures 2, 3 and 4. One source of heat loss is through **RADIATION**. Just as you feel heat “radiating” from a fireplace, your home radiates heat to the outside in the winter and is on the receiving end of heat radiated by our sun to the inside in the summer. There have been attempts to minimize the amount of heat lost or gained through radiation by wrapping homes with foil-like materials that reflect radiation back into the house or away from the home, to the outside environment, depending on the season. In Midwest climates, these foil-like materials are generally less cost-effective than in southern states where solar gains are higher.

However, radiation is also the idea behind low thermal emissivity (low e) glass in energy-efficient windows. Using low e glass in windows, along with light colored roofing and siding materials, and locating windows so that they are not directly impacted by sun’s radiation in the summer, are all economical ways to reduce the impacts of summer radiation and help lower cooling costs.

The second way heat is gained and lost is through **CONDUCTION**. Remember that heat always flows from a warm surface to a cooler surface. If the interior environment of your home is warmer than the exterior, heat will flow from the interior to the exterior through building walls, windows, doors, floors and roof/ceiling components. The amount of heat that flows through these building surfaces is dependent on the temperature difference between the environments separated by these surfaces and the rate of heat transfer through the materials involved. The greater this temperature difference, the greater the heat flow and the associated heat-loss or -gain. This heat-loss or -gain can be slowed by lowering the rate of heat transfer through building components with good insulating values.

The third way that a home loses heat is through **CONVECTION**. This is simply the transfer of heat through the movement of air. This type of heat transfer can be associated with uncontrolled air leakage into or out of the home, but also through convection currents that can occur within wall, floor and window cavities.

Moisture Control

In Illinois, moisture related problems in a home can occur in winter and summer. In winter, cold air only holds a small amount of water vapor, while warm air inside can hold a considerable amount from cooking, bathing and even the evaporation of standing water from fish tanks and plants. As this vapor level grows, it builds pressure indoors (a higher vapor-pressure), forcing the vapor into the walls and towards the outside, colder air (at lower-vapor pressure). When air is cooled, the relative humidity (RH) of the air (the amount of water vapor it can hold) increases. If the RH of the air reaches 70 percent or higher, mold growth can begin.

In summer, outdoor air that has a high RH, along with wind driven rains, can penetrate cracks and openings in the exterior sheathing. As it is forced inward into the wall cavity by wind, vapor and solar pressure, it can eventually reach interior, air-conditioned wall material. As the air carrying the water vapor is cooled, its RH will rise. Once again, if the RH reaches 70 percent or higher, mold can begin to grow.



Moisture problems can often lead to mold issues as shown in this attic.

The best strategies to prevent water vapor/moisture issues are complicated. Improper insulating methods can contribute to problems. When insulating homes in Illinois, we do not recommend installing a vapor retarder (such as 6-mil polyethylene plastic, insulation faced with kraft paper or certain thicknesses of closed-cell, high-density foam insulation products). This allows any moisture that does penetrate a wall cavity to

Moisture Control Cont.

eventually dry out. A latex or enamel paint primer-coat on the inside surface of exterior walls and ceilings, air-sealing and proper insulation levels are sufficient. By air-sealing cracks, holes, spaces around pipes and conduit, and joints between materials in exterior walls, floors and ceilings, air transport of water vapor to cold surfaces is restricted.

To eliminate summer migration of high humidity air into the wall cavity, the exterior of the home must have a continuous air barrier. Many builders use house wrap as the air barrier. For house wrap to truly be an air barrier, all seams and edges of the wrapping material must be sealed with tape, per the manufacturer's recommendations. The house wrap should also continue upwards to cover gable ends of the home in such a fashion that

wind driven rain is not able to drain behind the wrap.

There are many new products being developed to ensure homes have a continuous air barrier on the exterior while ensuring the home is structurally sound and simplifying construction in an economical fashion. One of these newer products is an exterior sheathing that has a special coating on the exterior that serves as an air and vapor barrier, simplifying construction. Seams are sealed with a special tape to make sure the exterior of the home is air sealed.

In most homes, various combinations of materials, installation methods, and air sealing techniques are incorporated to provide for both vapor diffusion control and the control of air transported moisture.

Recommended Construction, Air-Sealing & Insulating Standards

Air Leakage (Caulking and Sealing)

Air leakage is responsible for 30% or more of the energy loss in homes. All joints, seams, and penetrations between the inside and outside of the home should be sealed. Caulk, spray foam, weather stripping and continuous building air barrier, are used to seal air leaks. Stopping air infiltration is easy to do during construction, but often overlooked and covered up. As depicted in figure 6, the following areas require special attention.

1. Box sill (rim joist): use a sill sealer gasket, caulk or foam, and insulate box sill cavity. Don't use fiberglass insulation in the box sill.
2. Junction of foundation and sill plate: caulk or foam to subfloor or use sill sealer.
3. Junction of top plate and top of exterior walls: caulk or foam the joints.
4. Knee walls: sealed and blocked with caulk or foam.
5. Headers: caulk or foam joints on all four sides.
6. Spaces created by electric, plumbing, heating and air-conditioning service penetrations, and any other openings made in the plate: seal with caulk or foam. This includes all interior and exterior walls.
7. Switch plates, receptacles and junction boxes facing to the exterior: caulk to the exterior boxing.
8. Gaps around all HVAC register boots and openings: caulked or sealed with foam to the subfloor or drywall.
9. Rough openings around doors, windows and skylights: sealed with caulk, gaskets, non-expanding foam and exterior flashing tape.

10. Duct and flue shafts: sealed and blocked with caulk or foam.

11. Shower and tub-surrounds: install a rigid air barrier between wall cavities and surrounds; caulk or foam. (Wall and ceiling cavities should be insulated prior to shower/tub installation.)

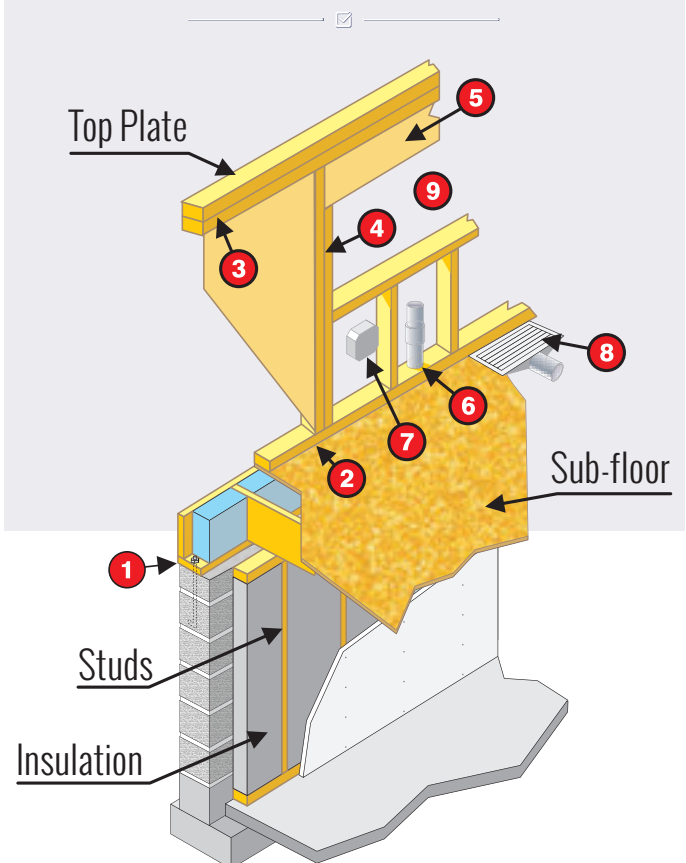

Walls

All exterior walls should be framed to avoid un-insulated air pockets, using construction methods that allow for full-depth of insulation in exterior walls. (figure 7) Cold corners, often caused by poor corner construction or incorrect insulating, can lead to condensation in these areas; if left unchecked, mildew or mold issues can result. Whether your builder uses 2x4 or 2x6 exterior wall construction techniques, insulated headers are required over doors and windows, as depicted in figure 8.

There are several methods that can be used to meet exterior wall insulation requirements of Illinois Touchstone Energy Home. For information on code requirements see the table (below) on insulation and fenestration requirements from the 2012 IECC code book.

For 2x6 wall construction, you may use the exterior sheathing material of your choice with R-20 insulation in the wall cavity, as long as the wall assembly includes the use of a latex or enamel paint as an interior vapor barrier.

For 2x4 wall construction, continuous insulating sheathing (rigid board insulation) is required on the building exterior to maintain a consistent total sheathing thickness. The above-mentioned vapor barrier, along with R-13 insulation in the wall cavity, is required.

Illinois Touchstone Energy Home recommends the use of

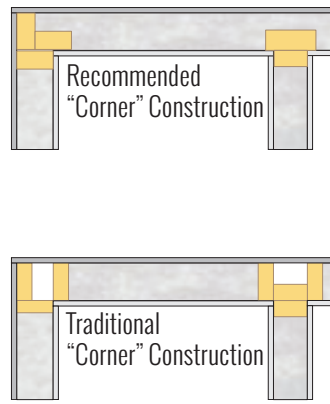

fig. 7

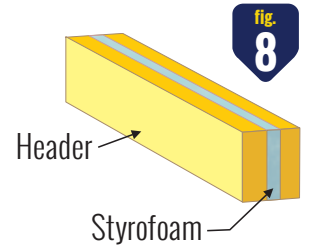

fig. 8

dense-packed cellulose wall insulation for newly constructed homes. Dense-packed cellulose wall insulation is an efficient, cost-effective material for insulating exterior walls. Cellulose insulation ensures there are no un-insulated pockets in an exterior wall, it improves air sealing, and provides sound proofing. This gives cellulose an advantage: cellulose insulation types tend to retard air leakage. This helps air seal the home, thereby contributing to lower heating and cooling costs. Properly installed polyurethane spray foam insulation has many of the same advantages as cellulose, and is an outstanding insulating and air-sealing product. However it generally is more expensive to install.

Insulation and Fenestration Requirements by Component^a

fig. 9

CLIMATE ZONE	FENESTRATION U-FACTOR ^b	SKYLIGHT ^b U-FACTOR	GLAZED FENESTRATION SHGC ^b	CEILING R-VALUE	WOOD FRAME WALL R-VALUE	MASS WALL R-VALUE ^c	FLOOR R-VALUE	BASEMENT ^d WALL R-VALUE	SLAB ^d R-VALUE & DEPTH	CRAWL SPACE ^e R-VALUE
4 except Marine	0.35	0.55	0.4	49	20 OR 13+5 ^f	8/13	19	10/13	10, 2 ft	10/13
5 and Marine 4	0.32	0.55	NR	49	20 OR 13+5 ^f	13/17	30 ^g	15/19	10, 2 ft	15/19

For SI: 1 foot = 304.8 mm.

- a. R-values are minimums. U-factors and SHGC are maximums. When insulation is installed in a cavity which is less than the label or design thickness of the insulation, the installed R-value of the insulation shall not be less than the R-value specified in the table.
- b. The fenestration U-factor column excludes skylights. The SHGC column applies to all glazed fenestration. Exception: Skylights may be excluded from glazed fenestration SHGC requirements in Climate Zones 1 through 3 where the SHGC for such skylights does not exceed 0.30.
- c. "15/19" means R-15 continuous insulation on the interior or exterior of the home or R-19 cavity insulation at the interior of the basement wall. "15/19" shall be permitted to be met with R-13 cavity insulation on the interior of the basement wall plus R-5 continuous insulation on the interior or exterior of the home. "10/13" means R-10 continuous insulation on the interior or exterior of the home or R-13 cavity insulation at the interior of the basement wall.
- d. R-5 shall be added to the required slab edge R-values for heated slabs. Insulation depth shall be the depth of the footing or 2 feet, whichever is less in Climate Zones 1 through 3 for heated slabs.
- e. There are no SHGC requirements in the Marine Zones.
- f. Basement wall insulation is not required in warm-humid locations as defined by figure R301.1 and Table R301.1.
- g. Or insulation sufficient to fill the framing cavity. R-19 minimum.
- h. First value is cavity insulation, second is continuous insulation or insulated siding, so "13-5" mean R-13 cavity insulation plus R-5 continuous insulation or insulated siding. If structural sheathing covers 40 percent or less of the exterior, continuous insulation R-value shall be permitted to be reduced by no more than R-3 in the locations where structural sheathing is used - to maintain a consistent total sheathing thickness.
- i. The second R-value applies when more than half the insulation is on the interior of the mass wall.

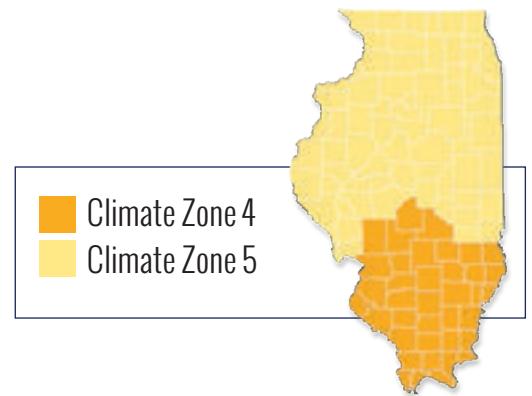

Touchstone Energy Home recommends dense-packed cellulose insulation in the exterior walls, as a best practice. By comparison, fiberglass batt insulation is more prone to air leakage, while cellulose insulation helps eliminate leakage. However, if fiberglass batt insulation is used, proper installation is essential.

If installing fiberglass batts, it is necessary to cut the insulation to fit around obstructions. Battas are never to be compressed behind wiring, plumbing or other obstructions as this greatly diminishes the insulating performance of the batts.

Figure 9 shows the right and wrong ways of installing fiberglass insulation.

Examples of improper installations are:

- (a) Battas that have been compressed behind wiring, plumbing and other obstructions;
- (b) Battas improperly cut to fit the opening;
- (c) Battas not installed to the top or bottom of the stud cavity;
- (d) Battas not fitting snugly together.
- (e) Battas installed in an unsealed wall cavity.

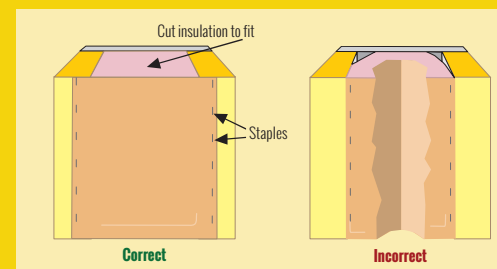

Basement Walls

Many people think that, since their basement is used only for storage, it's an "unconditioned" space that doesn't need to be insulated. But in most cases heat will be transferred to the basement area from the rest of the house, so insulation is required on the basement walls. A basement is unconditioned only if the floor above the basement is insulated to the level shown for floor R-value in figure 9 on page 7, the walls of the stairs leading to the basement are insulated to the levels required for exterior walls, the door leading to the basement from the conditioned living space above is insulated and weather-stripped, no duct registers are located in the basement and all ducts exposed to the basement are sealed and insulated to R-6.

Exterior walls in conditioned basements are to be insulated to the standards shown in figure 9 on page 7. This can be done by framing out the walls and using either sprayed or rigid foam board insulation. Rigid foam can be fitted and sealed in the framing cavities, or attached to the wall behind the framing lumber.

When insulating the basement or crawl space, do not forget to insulate the box sill (rim joist) to the R-value required for exterior walls. Moisture control should be considered as basements and crawl spaces tend to contain fairly high levels of water vapor. Insulating materials should prevent moisture from being carried to the cold wood which can cause rot and decay. Don't use fiberglass batt insulation on the box sill (rim joist) as fiberglass can allow moisture-laden air to pass through it and come into contact with cold surfaces. Another area similar to the box sill is the band joist in two-story construc-

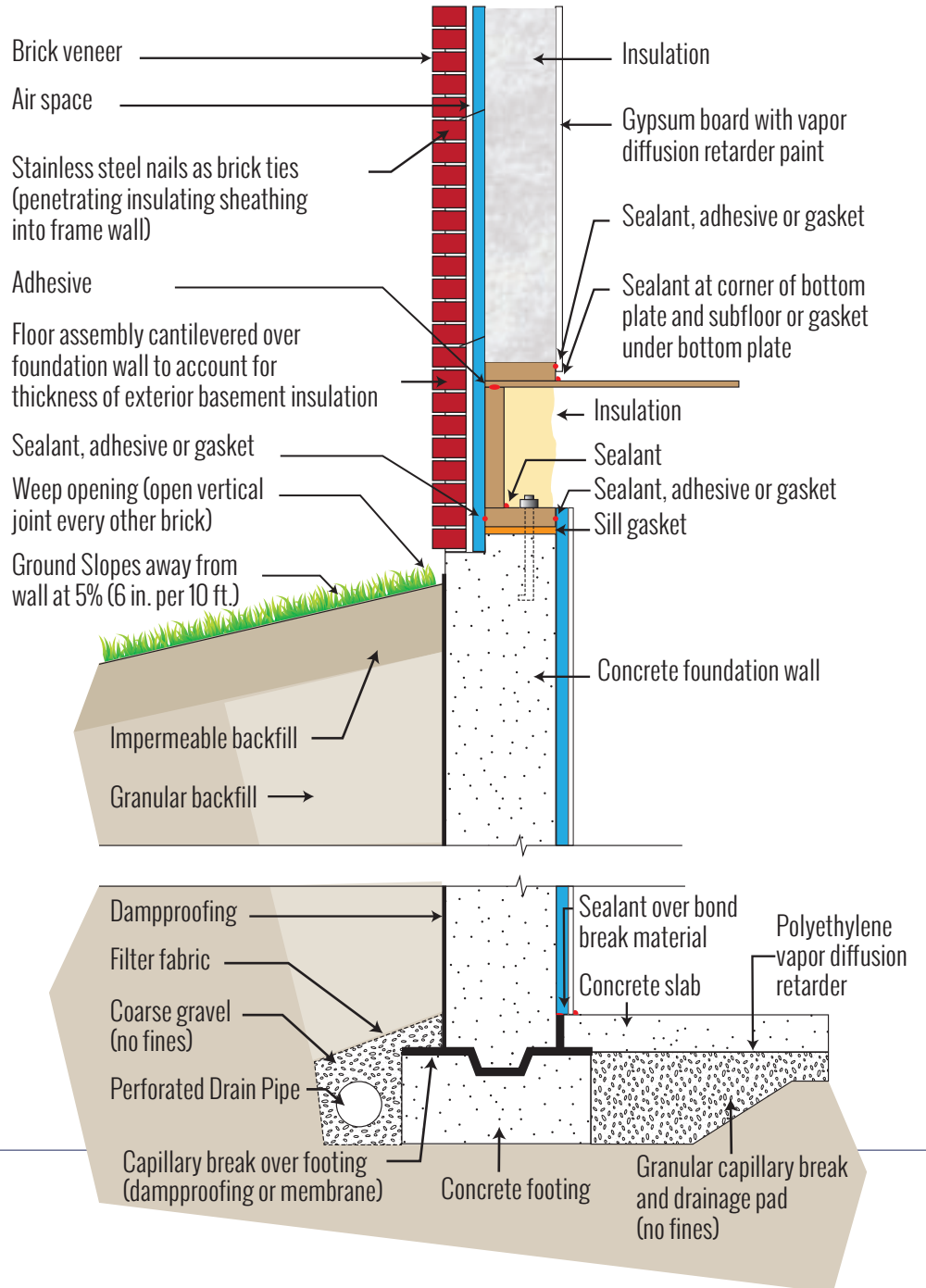

fig. 10

When insulating the basement or crawl space, do not forget to insulate the box sill.

tion. The band joist must also be insulated to the same R-value as the exterior walls above and below it. [Illinois Touchstone Energy Home recommends](#) foam insulation in the box sill and band joist as the best practice.

Structural Insulated Panels

An alternative to standard 'framed' construction is called structural insulated panels or SIPs. These are engineered panels of insulating foam sandwiched between two pieces of rigid material – plywood, OSB (or wafer-board), gypsum wall board or sheet metal. Manufactured in many sizes, structural insulated panels are available for residential wall construction in 4' x 8' sheets and larger.

Structural insulated panels are engineered and constructed to act as 'T' beams. They are extremely strong, resist bending and buckling and are load bearing. They can be used as sub-flooring over crawl spaces for insulated floors and can deaden sound. They can also be used in roof and ceiling construction.

Structural insulated panel walls have higher R-values than their comparable, framed-wall counterparts. With fewer joints to seal there is a low air infiltration rate.

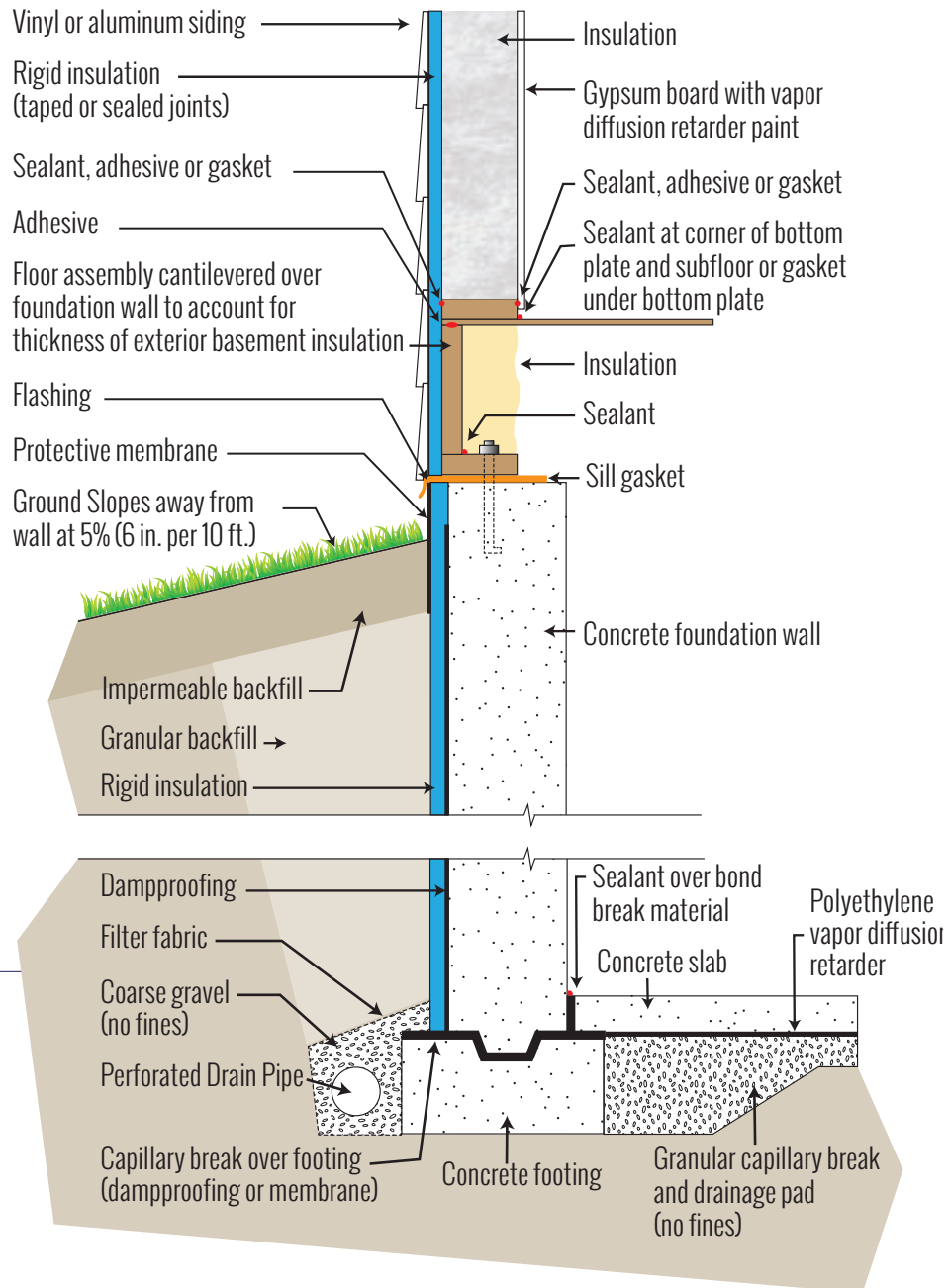

fig. 11

Fig. 10 & 11
Proper wall construction methods above and below grade

Insulated Concrete Forms



Insulated Concrete Forms (ICF) can be used in place of traditional forms when pouring concrete for basement wall construction. They can also be used for above grade wall construction as desired. Made with expanded polystyrene, ICFs result in walls with insulating values of R-20 and higher. Most homeowners plan to insulate and finish their basement later, but end up with a cold basement and high heating bills. Insulated Concrete Forms avoid this problem.

As the concrete core of an ICF wall is connected to the footing, it is important that ICF wall footings are installed deep enough to ensure the footing isn't exposed to freezing temperatures that can wick heat from the wall core. Installers should follow the manufacturer's recommendations for footing depth.

There are two types: rigid sheets of foam board held together with plastic or metal ties, and interlocking, stackable foam blocks. Reinforcing steel can be added as needed. Furring strips are provided so that wall finish materials can be added later.

Steel Framing

When the price of wood products increases builders look for alternatives. One alternative to standard wood studs is steel framing. As a recycled product, steel framing has several advantages such as price stability and consistent size. Steel framing is lighter, does not twist, shrink or warp and of course is not affected by termites.

Unfortunately steel framing has one fatal flaw—it is prone to conductive heat loss. The thermal bridging created by steel framing lowers the effective R-value of the wall by as much as 50 percent. The best alternative is to install insulated sheathing in a continuous manner on the entire exterior surface of the wall. **We do not recommend steel framing for The Illinois Touchstone Energy Home.**

Blower Door Test

Home builders must demonstrate they have sealed air leaks in new homes by performing a “blower door” test (figure 12). The Illinois Energy Conservation Code requires blower door testing in new homes. Having a home professionally inspected and/or tested is an important safeguard for consumers. New home owners should have a copy of the test results. New homes constructed in Illinois after December 31, 2012, must demonstrate a tested air leakage rate of “five air changes per hour (5ACH) when measured with a blower door at a pressure of 0.2 inches w.c. or 50 Pascal (50Pa).”



Roof/Ceiling Construction and Ventilated Attics



Illinois Touchstone Energy Home recommends loose-blown cellulose in the attic to provide uniform insulation coverage with minimal air movement problems.

Roof pitches greater than or equal to 6-in-12 are recommended. This allows for fewer restrictions at the eaves and provides for better attic ventilation. As the roof deck is steeper, air will be easily directed via eave openings and ventilation baffles to the peak where it can exit through the ridge vents. The additional height also allows for better working conditions in the attic. In a roof with less than a 6-in-12 pitch, much of the ceiling will have less insulation than recommended because conventional rafter and truss construction tends to compress roof/ceiling insulation levels at the roof eave-wall line interface. Raised-heel or energy truss construction allows for full-developed-depth of roof/ceiling insulation eliminating the reduction in roof/ceiling effective R-values caused by compression of the insulation, as shown in figure 13. For information on attic insulation requirements, see the insulation and fenestration chart from the 2012 IECC code book on page 7.

The number of openings through the ceiling should be minimized to maintain the building integrity and achieve low

energy consumption. Attic access ports should be placed in unconditioned areas, such as the garage. If this is not possible, access ports should be insulated and weather-stripped. Typical methods are shown in figures 14 and 15. Whole-house attic fans are not recommended. Easy access in the attic should also be provided, such as a catwalk, as shown in figure 16.

Soffits in kitchens and bathrooms should be constructed after the ceiling and wall material have been installed. This will maintain the integrity of the ceiling surface. Any recessed lighting that is used should be installed in a sealed soffit area. If recessed lighting cannot be installed in this manner, lights must be labeled “air-tight” and IC-rated (suitable for Insulation Contact) or have insulated, air-tight boxes constructed to cover and enclose them.

All attics above conditioned spaces are to be insulated to a minimum R-49. Where “raised-heel” truss construction is utilized, this insulation level can be dropped to R-38. Insulating materials must extend completely over the top plate of walls at the attic perimeter to eliminate cold corners in rooms below.

Illinois Touchstone Energy Home recommends that knee walls or any wall exposed to the ventilated attic area be insulated to

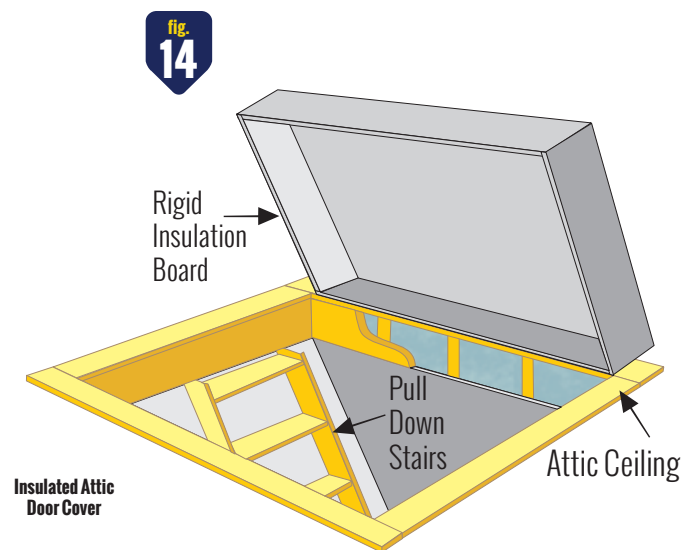
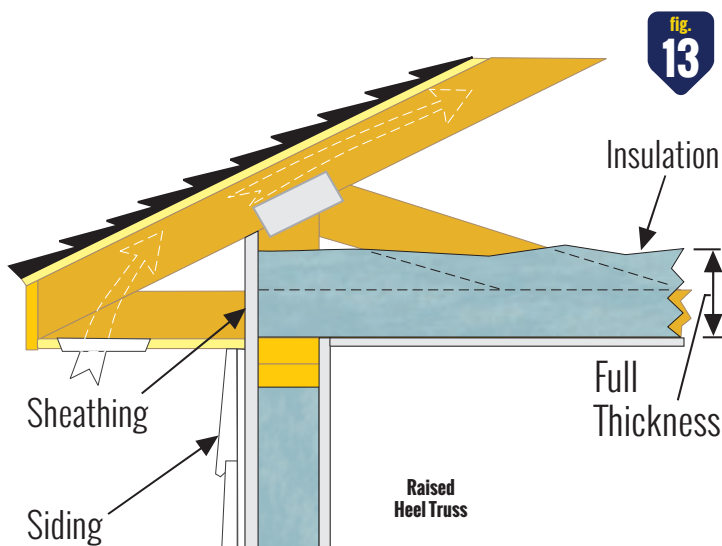

the level required for attics. Attics can reach extreme temperatures in both winter and summer months. Fiberglass insulation, either batt or loose-fill, is not recommended for use in any attic space. Fiberglass batts, although not recommended, if used must be trimmed and cut to fit snugly around obstructions, such as exhaust fans and truss members. To avoid these problems Illinois Touchstone Energy Home recommends that loose-fill cellulose insulation be used for roof/ceiling and attic locations.

Attics must have proper ventilation, not only to help reduce temperatures during the summer, but also to allow any moisture that may build up in the winter to escape. Adequate attic ventilation is crucial to the overall energy efficiency performance of the home.

One last suggestion: some homeowners and builders may use tongue and groove wood for ceiling construction. This application does not provide a proper air seal by itself, as wood often cracks and shrinks with time. If using wood on the ceiling, apply it over a properly sealed drywall surface.

In the attic itself, eave baffles of any solid material should be installed adjacent to soffit and eave vents and extending over the top of the attic insulation. Eave baffles keep air movement from air-washing the insulation (reducing its R-value) or blowing-away loose-fill insulation types from the attic perimeter. Ventilation openings should include soffit vents as well as ridge vents or static vents as shown in figure 17.

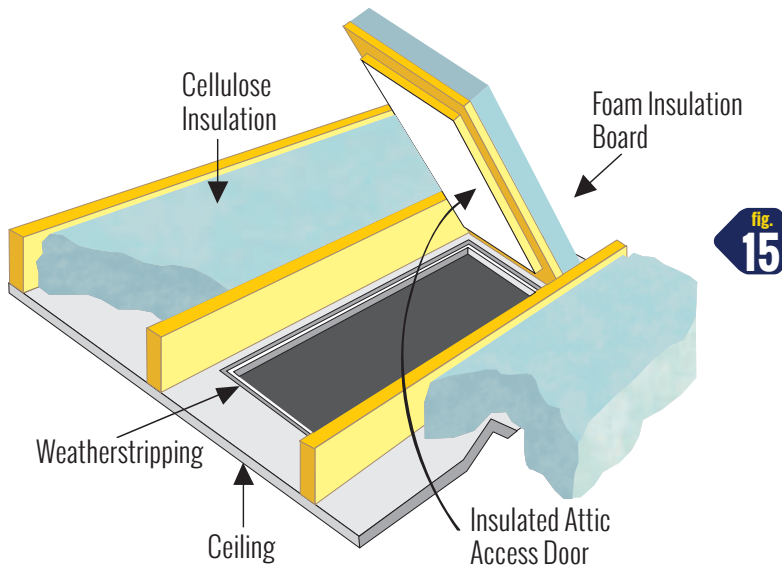

fig. 15

A passageway should be provided to permit access through the attic without compressing the insulation. For attic storage, expand the areas as illustrated.

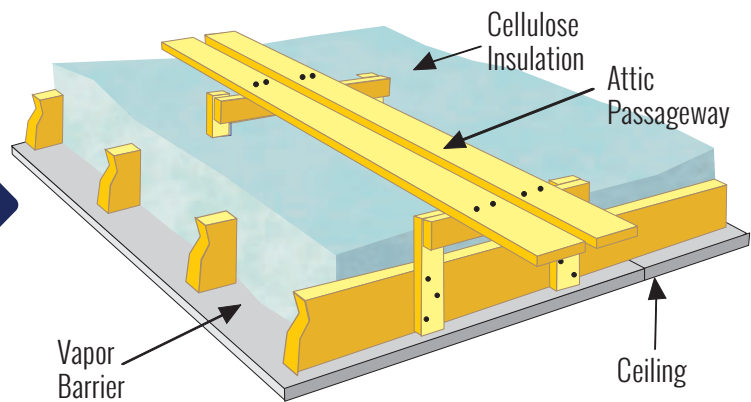

fig. 16

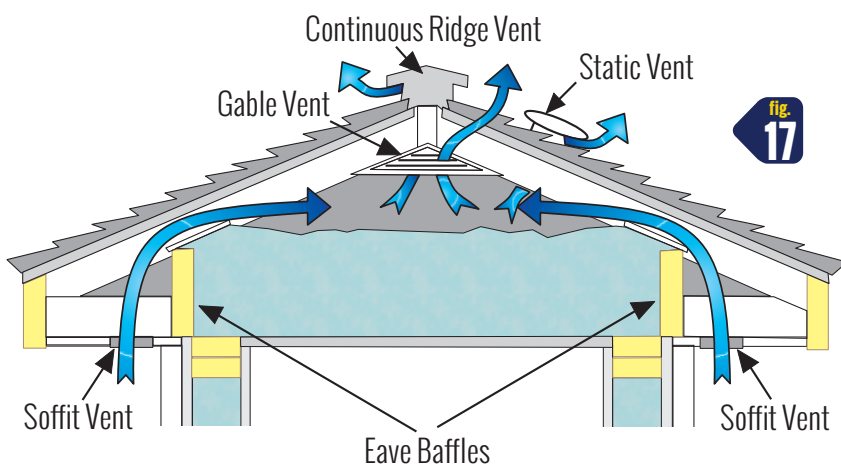

fig. 17

Properly sized inlets and outlets must be provided to allow air circulation through the attic. If a continuous ridge vent is not installed, then roof or gable vents should be used.

Floors



The floors above unconditioned basements, crawl spaces and garages are to be considered as part of the building thermal envelope and should be treated accordingly. All openings in the floor surface are to be sealed and closed off. This includes openings for duct systems (especially register boots), electrical, telephone, security and CATV wiring systems, as well as plumbing and fuel gas-piping systems. The drain area for bathtubs and showers are especially important, as these are normally very large openings.

Where the garage ceiling is part of the building thermal envelope with the garage ceiling being the floor for the conditioned living space above an air-tight barrier is required to prevent the migration of automobile exhaust gasses into the living space.

Floors Over Crawl Spaces

Floors over unconditioned crawl spaces should be insulated. Refer to figure 9 on page 7 for minimum insulation values. (One method of accomplishing this is by installing insulation between the floor joists with sufficient support provided such that the insulation maintains permanent contact with the underside of the subfloor.)

If water lines, heating, and/or air-conditioning ducts are present in the crawl space, it may be best to insulate the crawl space walls rather than the floor/ceiling above to prevent pipes from freezing and energy losses through un-insulated ducts. **Illinois Touchstone Energy Home recommends** the use of spray or rigid foam on crawl space walls.

A 6-mil polyethylene plastic, continuous ground-covering material must be installed on the floor of the crawl space to prevent ground moisture from entering the crawl space area, as shown in figure 18. This barrier must be turned up the sides of the walls at least 6-inches and sealed, with joints also lapped at 6-inches and sealed. Crawl space wall ventilation openings are prohibited where crawl space walls are insulated. In such a case, the crawl space shall be conditioned or mechanically ventilated.

Concrete Slab Floors

The perimeter of concrete slab floors on or at grade are often subject to significant temperature extremes (and high levels of heat loss), particularly at the slab-edge. Concrete slab floors less than 24-inches below grade (including walk-out basements), must have their perimeter insulated. This can be done by installing rigid foam board insulation downward from the top of the slab on the outside or inside of the foundation

wall; or downward to the thickness of the slab, then inward, horizontally from the perimeter. (See figure 19). Where heating elements, hydronic tubing, or hot air distribution systems are in contact with, or placed within or under the slab, **Illinois Touchstone Energy Home recommends** the entire area below the concrete must be insulated with minimum R-10 rigid foam board.

For insulation depths in all floor applications, please refer to chart from the 2012 IECC on page 7.

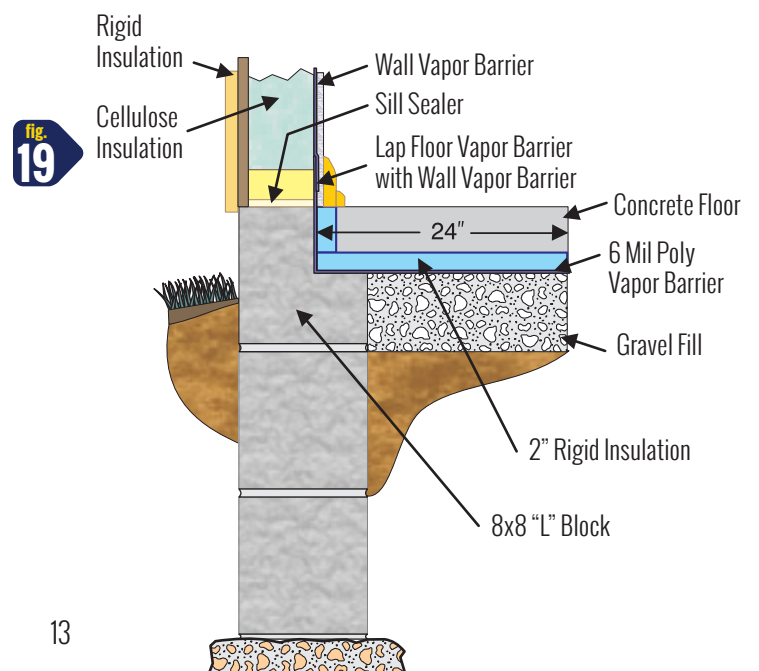
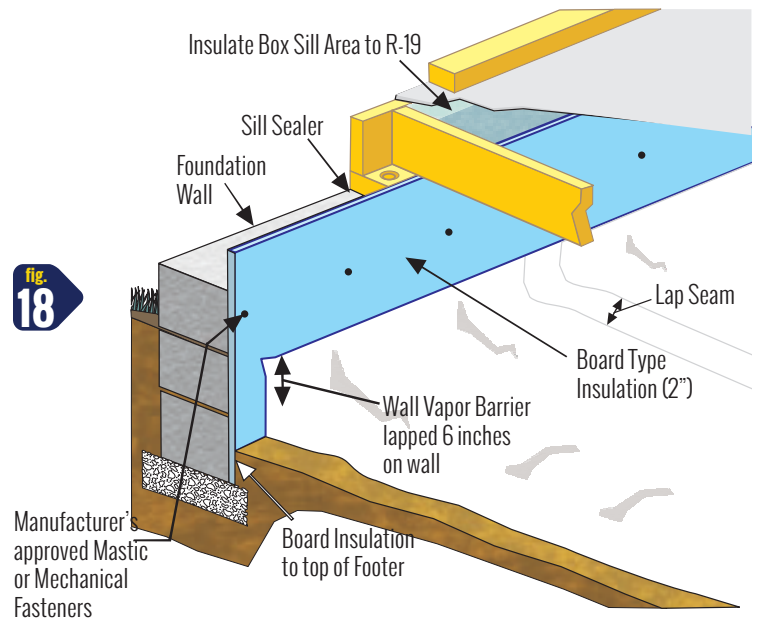

Windows & Doors



Although windows and doors can add to the overall appearance of your home, they very seldom add to the overall energy efficiency as they are made of glass, wood, vinyl and aluminum, which are considered poor insulating materials. Because they are such a large source of energy loss, and just as much of an opportunity for improving the comfort of your home, the quality of the doors and windows you select should not be sacrificed to bring the building budget back in line.

Casement and awning type windows generally have less air infiltration than slider- and double-hung-type windows, and should be considered if they meet the design and architectural style of the home. Most window manufacturers now use a rating system developed by National Fenestration Rating Council (NFRC). This NFRC rating provides a standardized method of comparing window performance. (See figure 20.) Your building center or builder can furnish you with this information. One rating standard is U-factor. U-factors are used to indicate the insulating value of doors and windows. Unlike R-value, the lower the U-factor the higher the insulating value.

Because windows and glass doors are major areas of heat loss and heat gain, Illinois Touchstone Energy Home recommends they should be sized so they are no more than 10 percent of the conditioned floor area of your home. In other words, if you are building a 2000 square foot home, the total area windows and glazed doors should be less than 200 square feet.

Windows that face east or west should be kept to a minimum. As the sun rises and sets in these directions, these windows are subject to direct rays from the sun and can lead to high heat gains in the summer months—making your air-conditioner work harder. In fact, it has been estimated that a window facing west can add as much as a half ton of cooling requirement to the house. Windows that must face these directions should be shaded with deciduous trees, blocking the sun in the summer, but allowing the sun's warming rays to strike the window in the winter.

	World's Best Window Co. Millennium 2000+ Vinyl-Clad Wood Frame Double Glazing • Argon Fill • Low E Product Type: Vertical Slider	
	ENERGY PERFORMANCE RATINGS	
U-Factor (U.S./I-P) 0.35	Solar Heat Gain Coefficient 0.32	
ADDITIONAL PERFORMANCE RATINGS		
Visible Transmittance 0.51	Air Leakage (U.S./I-P) 0.2	
<small>Manufacturer stipulates that these ratings conform to applicable NFRC procedures for determining whole product performance. NFRC ratings are determined for a fixed set of environmental conditions and a specific product size. Consult manufacturer's literature for other product performance information. www.nfrc.org</small>		



South-facing windows are excellent where ample overhang is provided to shade the window in the summer months. As the angle of the sun falls lower in the winter, the sun's warming rays can still pass through the window on sunny winter days contributing heat energy to the home, but are blocked during the summer. Deciduous trees are again excellent for this purpose.

Windows, at a minimum, must be double-pane, low-E glass, and have a NRFC tested U-factor of 0.32 or lower.

Low-E windows have a thin coating that reflects some of the sun's ultra-violet rays during the summer, helping to

fig. 21

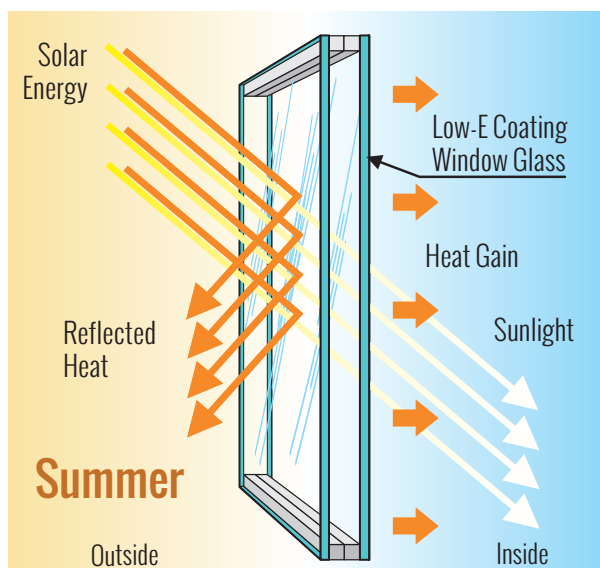
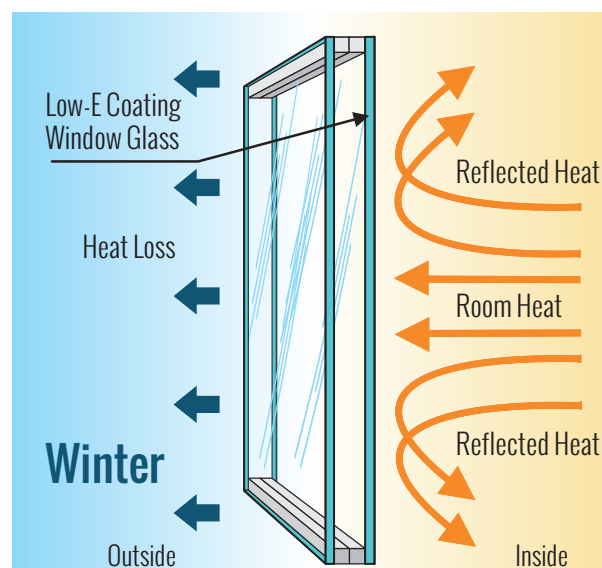

fig. 22



reduce heat gain as shown in figure 21. It also reflects some heat back into the conditioned living space in the winter, as shown in figure 22. It is recommended that you consider purchasing windows with an inert gas between the panes of glass. Gases such as argon, krypton and xenon are often used since (at normal temperatures) they do not transfer as much heat compared to air.

Two types of windows that need special attention are bow and bay windows. Since these windows have a “ceiling and floor” to them, they need to be insulated to the required ceiling and floor levels. Particular attention should also be given to the need for controlling air infiltration with these types of windows. Caulk, spray foam and exterior flashing tape must be used to seal any cracks in framing and siding materials. “Garden” windows are not recommended as they are prone to condensation and heat loss concerns.

All doors that separate conditioned areas from uncondi-

tioned areas are to be insulated and have weather-stripping installed (see figure 23). This includes doors that lead from the conditioned living space to the unconditioned garage. Thresholds must be caulked with continuous beads to the sub-floor. Metal or fiberglass doors with a foam core and a thermally broken door frame are recommended. Glass area in exterior doors should be kept to a minimum and all recommendations concerning windows apply to the glazed areas of exterior doors.

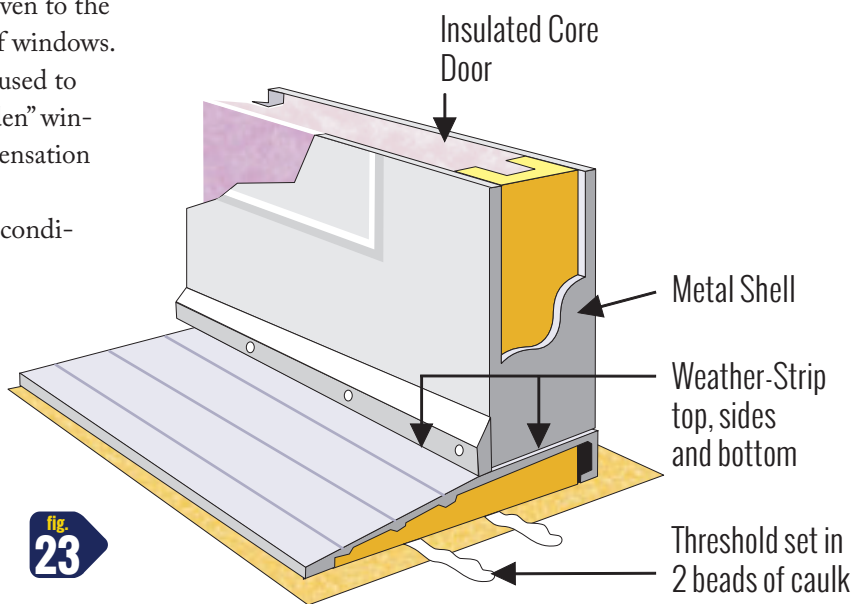

Heating, Ventilation & Air-Conditioning Systems (HVAC)



System Selection

Your home's HVAC system(s) not only consumes huge amounts of the total energy budget, but also impacts the comfort and well-being of the occupants (your family) more than any other system in the home. Accordingly, the more efficient the system that is installed, the lower your annual operating costs will be. The most cost-competitive method for heating and cooling your home is the geothermal heat pump with the second being a high-efficiency, air-to-air heat pump. Geothermal and air to air heat pumps, which move heat energy rather than create it, are typically up to four times more efficient than gas furnaces.

Illinois Touchstone Energy Home recommends the installation of a geothermal heat pump in all new homes.

A geothermal heat pump is an extremely efficient, year-round heating and cooling system. It uses a ground loop system to transfer heat to and from your home (See figures 24-25.) According to the U.S. Environmental Protection Agency (EPA) geothermal systems are the most energy efficient, environmentally clean, and cost effective space conditioning systems available.

In addition to space conditioning, geothermal heat pumps can be used to provide domestic hot water when the system is oper-

ating. Most residential systems are equipped to transfer excess heat from the geothermal heat pump to the house's hot water tank, often saving 50 percent or more on water heating costs.

A frequent question asked about geothermal heat pumps is, "How long will it take to recoup my investment?" In general the incremental payback for residential geothermal systems is typically 2-5 years. The incremental payback is the additional cost of geothermal vs. a traditional HVAC installation ... reduced energy costs will lead to a payback of this additional investment, typically in 2-5 years. An accurate payback calculation can be provided by a qualified heating-cooling contractor or electric cooperative energy professional.

Moreover, instead of looking at the time it takes for payback, consider a simple monthly cash flow analysis. The additional monthly mortgage payment for the investment in a geothermal heat pump will be less than the savings generated every month by using the geothermal system, providing a positive cash flow each month.

An air-to-air heat pump operates similarly to a geothermal heat pump, except it does not have a ground loop system. It absorbs or rejects its heat to-or-from the outside air. Illinois Touchstone Energy Home recommends that air-to-air heat pumps have a minimum efficiency in cooling mode of at least 16 SEER (Seasonal Energy Efficiency Ratio).

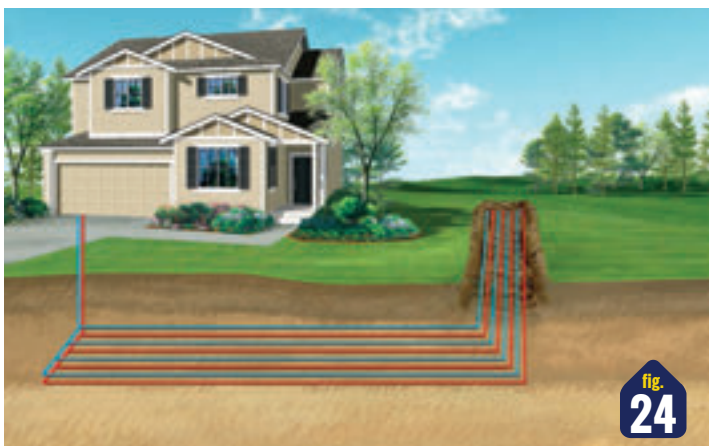

Two popular forms of geothermal closed loop systems are shown in these figures. At left is a horizontal system, with loops installed in a 5-8 foot trench. At right is a common vertical loop system, where loops are installed in vertical bore holes at depths of 150-200 feet or more.

Controls

Programmable thermostats can generate annual energy savings of up to 10 percent depending on fuel type. Homes with gas furnaces must have programmable thermostats installed. Regardless of the heating and cooling system in a home, programmable thermostats can save money and energy.

Heat pumps having supplemental electric-resistance heat must have controls that, except during defrost, prevent supplemental heat operation when the heat pump compressor can meet the heating load. In other words, any thermostat used with a heat pump should ensure the maximum usage of the heat pump, calling upon supplemental resistance heat only when necessary – typically in extremely cold weather.

Wood-burning appliances and gas fireplaces are not recommended by Illinois Touchstone Energy Home. If wood-burning or gas fireplaces are installed, they should have airtight doors, a tight fitting flue damper and outdoor combustion air should be supplied. An alternative to wood or gas fireplaces are an electric fireplace or sealed combustion gas log fireplace.

System Sizing

Improper sizing and installation of heating and air conditioning equipment can waste significant energy and result in costly utility bills. Your heating and cooling equipment must be sized according to Air Conditioning Contractors of America (ACCA) Manual ‘S’, based on loads calculated in accordance with ACCA Manual ‘J’.

Duct and Air-handling Systems

All ducts and air handler cabinets and filter manifolds are to be insulated and sealed. Leaky ducts can be responsible for 10-30% of energy loss in a home. Ducts within the building thermal envelope should be sealed and insulated to R-6. Ductwork should not be installed in unconditioned spaces, such as in attics, crawl spaces, or within building thermal envelope components (i.e., the floor/ceiling separating an unconditioned garage from the conditioned living space above). All ducts that must be located outside the thermal envelope need to be sealed and insulated to a minimum of R-8.

All ducts and air handlers are to be sealed with mastic (a special type of durable caulk that is easily visible); unlisted “duct tapes” are no longer recognized as a sealant. Either UL181-listed foil tapes or mastics are preferable as they will stand the test of time and help reduce energy wasted by air leaking to unoccupied areas of the home. Without proper sealing, your system will simply be heating (or cooling) the attic or crawl space – wasting considerable energy. In existing homes, leakage should be assumed and mastic should be applied along every joint, seam and connection.

Ventilation equipment, range hoods, ventilation fans, dryer exhaust, etc., must be equipped with back draft dampers installed in the duct system and vented to the exterior. Clothes dryer exhausts must not be directed to the interior living space, as the additional moisture, and sometimes by-products of combustion (gas dryers), introduced into the home can be detrimental.

Ducts must be tested and verified to have total leakage of no more than 4cfm/100 square feet of conditioned space, or 3cfm/100 square feet of conditioned space (if air handler is not installed), except where handler and all ducts are inside conditioned space. This is a “total” air leakage test — all ducts must be tested to the code’s standard.

Ventilation Air Requirements, CFM

Continuous Whole-House Ventilation System Airflow Rate Requirements

Floor Area (ft ²)	0-1 Bedrooms	2-3 Bedrooms	4-5 Bedrooms	6-7 Bedrooms	7+ Bedrooms
<1,500	30	45	60	75	90
1,500 - 3,000	45	60	75	90	105
3,001 - 4,500	60	75	90	105	120
4,501 - 6,000	75	90	105	120	135
6,001 - 7,500	90	105	120	135	150
>7,500	105	120	135	150	165

fig. 26

Whole-House Mechanical Ventilation

In the past, no specific requirements for ventilation were imposed for residential buildings. Natural ventilation was considered adequate to maintain indoor air quality. As envelope construction practices have improved, the need to provide fresh, outdoor air to homes by mechanical means has increased.

Residential buildings tested and verified as having an air leakage rate no greater than 5ACH50 (five air changes per hour) are required to install a whole-house mechanical ventilation system, individual exhaust fans, or a combination of such. Outdoor air ducts connected to the return side of an air handler shall be considered to provide supply ventilation.

Illinois Touchstone Energy Home recommends a heat or energy recovery ventilator (HRV/ERV) for mechanical ventilation. Recovery ventilators will exhaust stale air, but recover most of the BTUs to pre-warm or pre-cool incoming fresh air.

However, the whole-house mechanical ventilation system can be designed to operate intermittently where the system has controls that enable operation for not less than 25 percent of each four hour segment and the ventilation rate prescribed in Table M1507.3.3(1) is multiplied by the factor determined in accordance with Table M1507.3.3(2).2012.

Intermittent Whole-House Mechanical Ventilation Rate Factors

Run-Time Percentage in each 4-Hour Segment	25%	33%	50%	66%	75%	100%
Factor	4.0	3.0	2.0	1.5	1.3	1.0

fig. 27

Domestic Hot Water



Depending on the appliances, the number of occupants and the living habits of the occupants, energy consumption for the domestic hot water systems of your home can be substantial. It is the second highest energy user in the home after space conditioning. The following suggestions will help lessen energy consumption:

1. Water heaters should be set at no higher than 120 degrees Fahrenheit.
2. Dishwashers should be ENERGY STAR qualified where an ENERGY STAR category exists for the specific dishwasher type. Oftentimes, this means the dishwasher is limited by maximum water consumption standards and often equipped with a pre-heater to raise the temperature of the water only to the higher temperatures needed for sanitation of dishes.
3. All domestic hot water pipes should be insulated to a minimum level of R-3 and the domestic hot water tank should be placed on a piece of 2" foam board.

4. All water heaters should be placed as near the point of usage as possible and anchored to a wall or floor for seismic restraint.

5. Homes with a geothermal heat pump should have a desuperheater installed with the water heater. In this application, there should be two water heaters installed. One will serve as a buffer tank, preheating the water for the primary water heater. This buffer tank should be connected to the geothermal unit with a desuperheater connection. This desuperheater utilizes “waste heat” from the geothermal unit to provide a water heating boost, vastly increasing the overall energy efficiency of the system.

6. Use low-flow showerheads and faucets.

Lighting



Lighting can have a significant impact on the energy use in homes. Select high efficiency lamps, including compact fluorescents, high-efficiency halogens, and LED (light-emitting diode) lamps wherever possible. They are initially more expensive to install, but fluorescent and LED lamps use much less energy and are less expensive to operate, and last longer than incandescent lamps. Compact fluorescent and LED bulbs

are available for many applications – and they create less heat than incandescent bulbs. At least 75 percent of lamps in permanently-installed fixtures must be high-efficiency.

As mentioned earlier, recessed lights should be installed in soffits and not directly in the ceiling. If soffits are not practical, air-tight, recessed fixtures or surface track lighting are better choices.

Energy Certificate

All new homes must have a builder's Energy Certificate on or in the circuit breaker box (i.e. electrical distribution panel) listing the materials and equipment values and ratings that demonstrate that a new home meets Illinois' Energy Conservation Code requirements. The certificate is an important means by which the consumer can verify that the home complies with the code.

fig.
28

Energy Efficiency Certificate			
Permit No. _____			
Address _____			
Insulation Ratings		R-Value	
Roof/Ceiling	Without attic	R-49	
Walls	Frame	R-20 1/2	
	Mass	R-	
	Basement	R-20	
	Crawl-space	R-10	
Floors	Over unconditioned space	R-	
	Sub-slab (sqft)	R-10 1/2	
Drafts	Attic	R-20	
	Other	R-10	
Fenestration Ratings		NFRC U-Value	NFRC SHGC
Opaque doors	U-	0.18	0.07
Windows	U-	0.25	
Skylights	U-	0.47	
Equipment Performance		Efficiency	
Heating system	HP/FAUE	98	
Cooling system	COOLER	100	
Water Heater/Boiler	EFFICIENCY	0.67	
Builder/Designer: _____			
Certified by: _____ Date: _____			
Adopted Code Edition: _____			
THIS CERTIFICATE SHALL BE PERMANENTLY POSTED ON OR IN THE ELECTRICAL DISTRIBUTION PANEL AS REQUIRED BY ENERGY / RESIDENTIAL CODES			

Conclusion



Providing you with the information and construction techniques to live comfortably and economically in your new home is the objective of the Illinois Touchstone Energy Home program. If you build or have someone build your new home using these standards, we are certain that your home will provide you with the best comfort available with little additional investment and will also be energy efficient.

The importance of paying attention to detail and application during the construction process cannot be understated. Though some of the items presented in this manual seem insignificant, it is the use of the total concept that provides for large energy savings. Careless installation and lack of attention to detail can cause even the most well laid plans to go awry.

Should you have any questions concerning the ideas presented in this manual or desire more detailed information, contact your local electric cooperative. You may also want to contact your cooperative for information concerning any special energy programs that may be available.

Please understand that advances in material and technology are occurring constantly. There may be alternative construction methods that meet these standards. This manual has been prepared based upon material and information that is currently available. Your electric cooperative is a valuable source of information concerning new advances in construction and equipment and should be contacted concerning new developments.

Summary-Construction Specifications

Walls:

1. For 2x4 wall construction, there are two basic methods with various product options for cavity insulation types available:
 - a. A base wall assembly consists of the use of latex or enamel paint as the interior vapor diffusion barrier, along with R-13 insulation in the cavity. Illinois Touchstone Energy Home recommends the installation of dense-packed (R-3.5/inch) wet-spray cellulose, or spray-foam insulations and continuous R-5 continuous insulating sheathing (rigid board insulation) on the building exterior. Where structural sheathing (OSB—Oriented Strand Board) covers 40 percent or less of the exterior, the R-5 insulating sheathing may be reduced to R-2 insulating sheathing in the locations where structural sheathing is used—to maintain a consistent total sheathing thickness.*
 - b. Where structural sheathing (OSB) covers more than 40 percent exterior, the base wall assembly is a latex or enamel paint vapor diffusion barrier and R-13 insulation plus R-5 continuous insulating sheathing covering the entire exterior wall assembly. In other words, no reduction in the exterior continuous insulating sheathing thickness is permitted.
2. For 2x6 wall construction, you may use the exterior sheathing material of your choice provided:

The base wall assembly consists of the use of latex or enamel paint as the interior vapor diffusion barrier, along with R-20 insulation in the cavity (as recommended by Illinois Touchstone Energy Home), dense-packed (R-3.5/inch) wet-spray cellulose, or spray-foam insulations, installation of ventilated cladding over wood structural panels, fiberboard or exterior-grade gypsum wallboard, and a house wrapping air barrier on the exterior.

All walls will have new framing techniques for corner and partition posts, and insulated headers over doors and windows.

Basement Walls:

All heated basement walls insulated to R-15 minimum.

Box sills (rim joists) and band joists insulated to the level required for exterior walls.

Ceilings:

All ceilings insulated to R-49. Where “raised-heel” truss construction is utilized, this insulation level can be dropped

* Illinois Touchstone Energy Home relies on building total air sealing requirements validated through building diagnostic testing through the use of a blower-door, which makes the installation of an air barrier (or vapor-permeable wrapping) material optional, but likely. More will be explained on this topic later.

to R-38. Vaulted ceilings with roof-ceiling combination construction should be insulated with cellulose insulation. Recessed lighting installed in enclosed soffits and all ceiling perforations should be caulked, sealed or gaskets installed.

Floors:

Crawl Spaces: Floors insulated to a level of R-30, or a level of insulation sufficient to fill the nominal floor joist depth (no lower than R-19). Crawl space ground cover shall be a 6-mil polyethylene vapor retarder installed over it.

Slab Floors: All slab floors on grade (or less than 24” below grade) insulated to R-15 extending a total-developed depth of 24-inches.

Windows and Doors:

Window area not-to-exceed 12 percent of conditioned floor area.

All windows to be double-pane, low-E glass and gas filled. All doors separating conditioned areas from unconditioned will be insulated and weather-stripped. Maximum U-factors for glazed windows and opaque doors shall be U-0.32. Skylights maximum U-factor of U-0.55.

HVAC Systems:

Duct Work: All ducts in unconditioned spaces to be insulated to R-6 with all joints, seams and connections sealed with mastic.

Geothermal: All geothermal heat pumps should have a minimum 3.6 COP in the heating mode.

Air-to-Air Heat Pumps: All air-source heat pumps to have a minimum SEER of 14 in the cooling mode, and a minimum HSPF in the heating mode of at least 8.2. Touchstone Energy Home recommends a minimum 16 SEER air-source heat pump.

Ventilation:

No wood burning or gas fireplaces recommended.

All ventilation equipment to have back draft dampers and vented to the exterior, not the attic.

Domestic Hot Water:

Water heaters should be set at 120 degrees, dishwashers to be ENERGY STAR qualified, and DWH pipes insulated to a minimum level of R-3.

Lighting:

All lighting, or at least three of every four permanently-wired fixtures, to be fluorescent, compact fluorescent, or LED lamp fixtures.

Insulation Values

Material	Thickness (inches)	"R" Value
Clay and Concrete Masonry		
Sand and gravel concrete block	8"	1.11
Sand and gravel concrete block	12"	1.28
Face brick	4"	0.44
Poured Concrete	8"	0.64

Building Materials-General	Thickness (inches)	"R" Value
Wood sheathing	3/4"	0.94
Fiberboard insulating	25/32"	2.06
Plywood	3/4"	0.93
Plywood	1/2"	0.62
Bevel lapped wood siding	1/2" x 8"	0.81
Bevel lapped wood siding	3/4" x 10"	1.05
Vertical tongue and groove (cedar and redwood)	3/4"	0.94
Gypsum board	1/2"	0.45
	5/8"	0.56
Interior plywood paneling	1/4"	0.31
Building paper	--	0.06
Vapor barrier	--	0.00
Asphalt Roof Shingles	--	0.44
Softwood (per inch)	--	1.25

Insulation Materials	Thickness (inches)	"R" Value
Blankets or batts (fiberglass)	3 1/2"	11.00
Blankets or batts (fiberglass)	6"	19.00
Cellulose (dry or sprayed on)	1"	3.70
Polystyrene (molded beads)	1"	3.57
Polystyrene (extruded smooth skin) Styrofoam	1"	5.26
Polyisocyanurate (sheathing)	1"	7.20
Spray polyurethane foam (closed cell)	1"	6.00
Spray polyurethane foam (open cell)	1"	3.50

Doors	Thickness (inches)	"R" Value
1 3/4" Metal Insulated Exterior Door w/ no glass	--	3.30
Patio Door	--	2.04
Patio Door (Low E Glass-gas filled)	--	3.13



 Association of Illinois
Electric Cooperatives

Your Touchstone Energy® Partner 

www.aiec.coop